

Katalog

Februar 2019

Catalog

February 2019

SpeedWall

Hoffmann GmbH  
SpeedDimension  
Gretlade 5  
31319 Höver, Germany  
Tel. +49(0)5132 / 86 87-15  
Fax +49(0)5132 / 86 87-44  
info@speeddimension.com  
www.speeddimension.com

Beispiel für Bauhöhenkombination  
Example of overall height combination

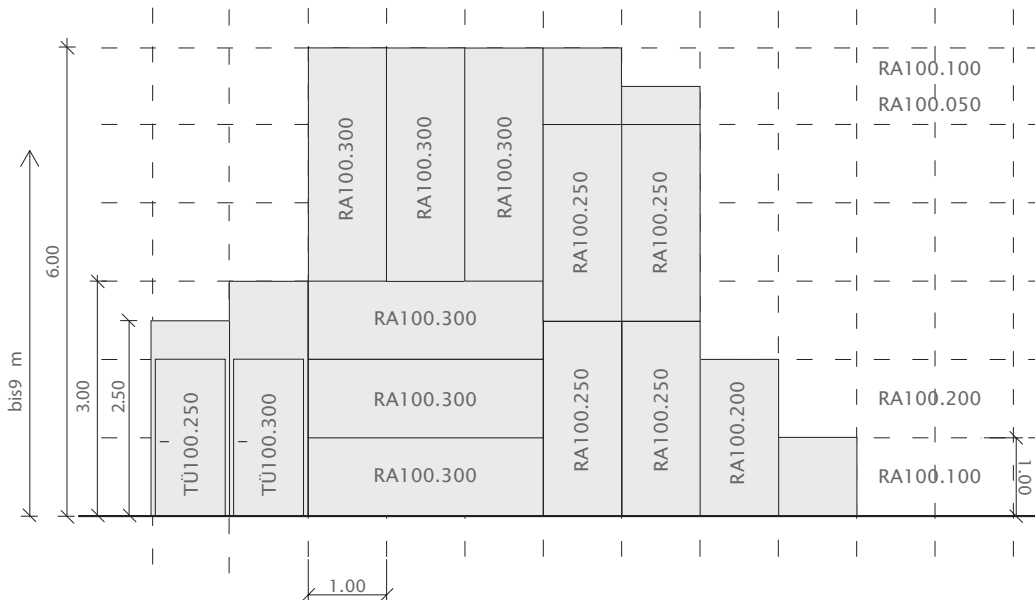

Beispiel Grundriss  
Layout example

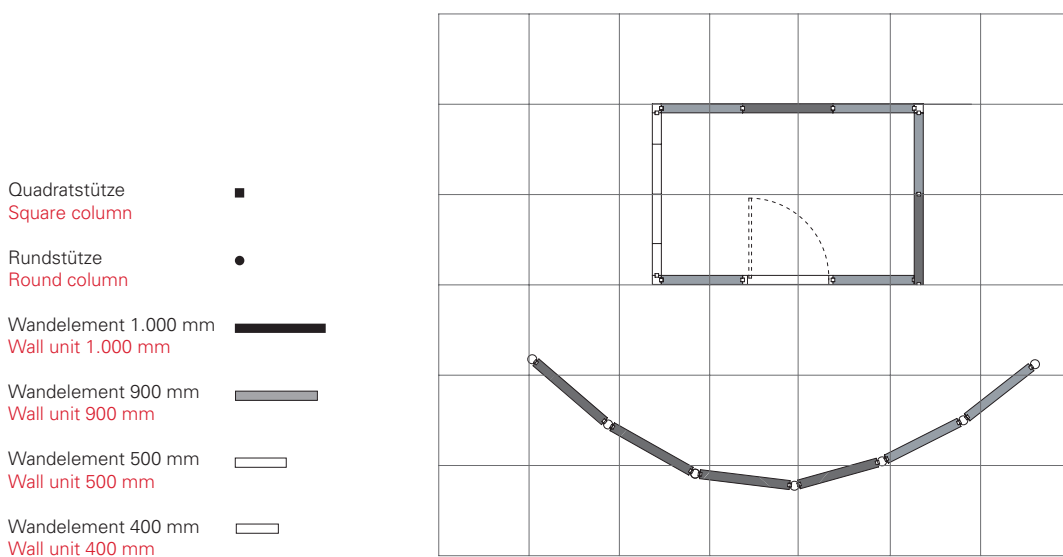

Segmentbau in 11,25°-Schritten  
Segments in 11,25°-steps

Segmentabwicklung mit Keilleisten 0° – 180°  
Segments with wedge grib from 0° – 180°

Grundrahmen und Zubehör  
Basic frame and accessory

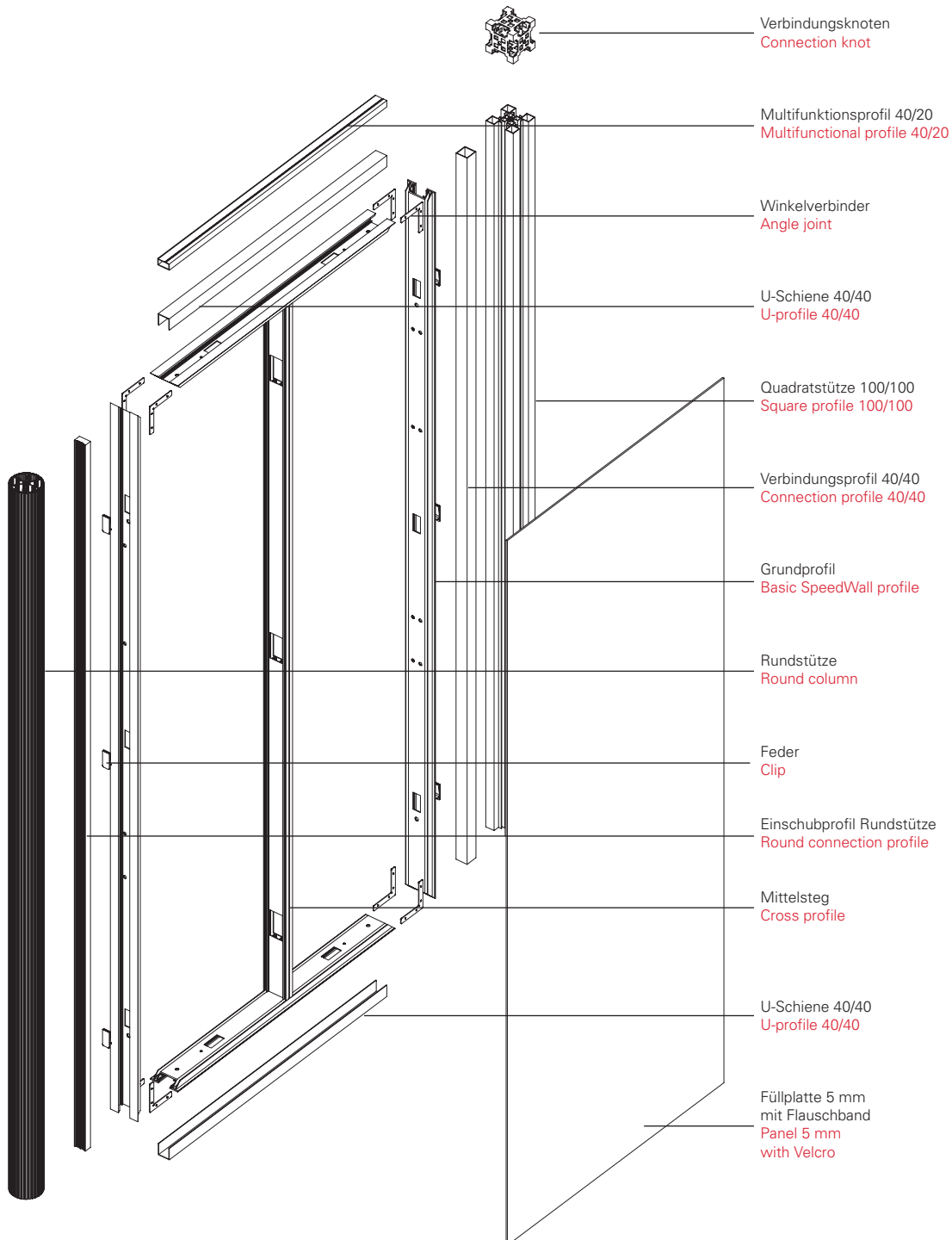

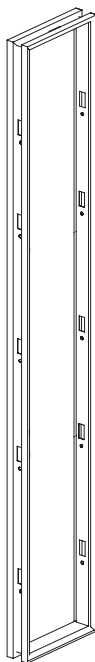

### Wandelement 400/100 Wall Unit 400/100

Breite Width	Höhe Height	Bestell-Nr. Order No.
400 mm	500 mm	RA040.050
400 mm	1.000 mm	RA040.100
400 mm	2.000 mm	RA040.200
400 mm	2.500 mm	RA040.250
400 mm	3.000 mm	RA040.300

Weitere Maße auf Anfrage. Ohne Zubehör.  
Dissentient dimensions on request. Without Accessories.



### Wandelement 500/100 Wall Unit 500/100

Breite Width	Höhe Height	Bestell-Nr. Order No.
500 mm	500 mm	RA050.050
500 mm	1.000 mm	RA050.100
500 mm	2.000 mm	RA050.200
500 mm	2.500 mm	RA050.250
500 mm	3.000 mm	RA050.300

Weitere Maße auf Anfrage. Ohne Zubehör.  
Dissentient dimensions on request. Without Accessories.

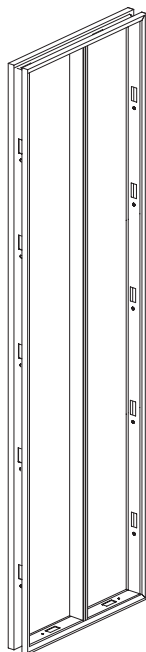
Rahmen  
FramesWandelement 900/100  
Wall Unit 900/100

Breite Width	Höhe Height	Bestell-Nr. Order No.
900 mm	500 mm	RA090.050
900 mm	1.000 mm	RA090.100
900 mm	2.000 mm	RA090.200
900 mm	2.500 mm	RA090.250
900 mm	3.000 mm	RA090.300

Weitere Maße auf Anfrage. Ohne Zubehör.  
Dissentient dimensions on request. Without Accessories.

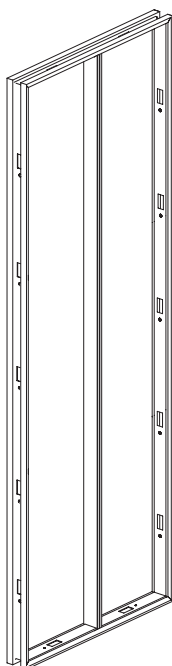
Wandelement 1.000/100  
Wall Unit 1.000/100

Breite Width	Höhe Height	Bestell-Nr. Order No.
1.000 mm	500 mm	RA100.050
1.000 mm	1.000 mm	RA100.100
1.000 mm	2.000 mm	RA100.200
1.000 mm	2.500 mm	RA100.250
1.000 mm	3.000 mm	RA100.300

Weitere Maße auf Anfrage. Ohne Zubehör.  
Dissentient dimensions on request. Without Accessories.

SpeedWall

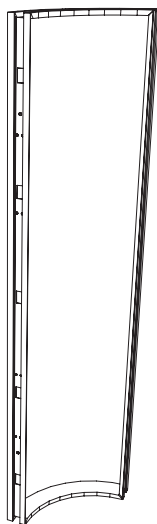
Rahmen  
rund  
Frames  
curvedSpeedWall rund Radius 500  
SpeedWall curved radius 500

Höhe Height	Bestell-Nr. Order No.
500 mm	RAC050.050
1.000 mm	RAC050.100
2.000 mm	RAC050.200
2.500 mm	RAC050.250
3.000 mm	RAC050.300

Aufdopplung für Hartschaumplatte (d=2mm)  
Support unit for expanded plastic slab (d=2mm)

Weitere Maße auf Anfrage. Ohne Zubehör.  
Dissentient dimensions on request. Without Accessories.

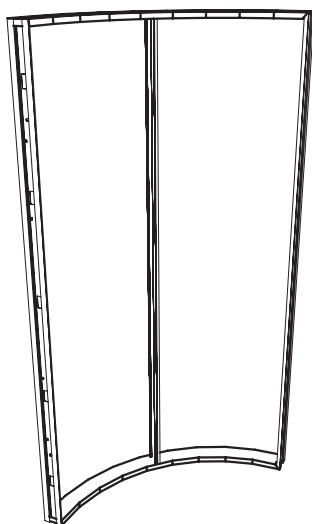
SpeedWall rund Radius 1.000  
SpeedWall curved radius 1.000

Höhe Height	Bestell-Nr. Order No.
500 mm	RAC100.050
1.000 mm	RAC100.100
2.000 mm	RAC100.200
2.500 mm	RAC100.250
3.000 mm	RAC100.300

Aufdopplung für Hartschaumplatte (d=3mm)  
Support unit for expanded plastic slab (d=2mm)

Weitere Maße auf Anfrage. Ohne Zubehör.  
Dissentient dimensions on request. Without Accessories.

SpeedWall

## Verbindungsprofil 40/40

### Connection profile 40/40

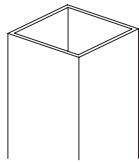

Länge  
Length

500 mm  
1.000 mm  
2.000 mm  
2.500 mm  
3.000 mm

Bestell-Nr.  
Order No.

VP040.050  
VP040.100  
VP040.200  
VP040.250  
VP040.300

## Aluminiumklettleiste für Wandplatten

### Velcro-fastening-fillet for panels

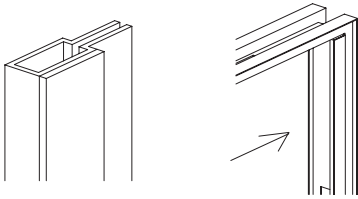

Länge  
Length

500 mm  
1.000 mm  
2.000 mm  
2.500 mm  
3.000 mm

Bestell-Nr.  
Order No.

KW040.050  
KW040.100  
KW040.200  
KW040.250  
KW040.300

## Hut-Profil

### Hat-profile

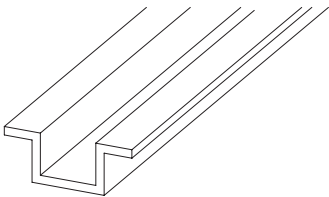

Breite  
Width

23 mm  
23 mm  
23 mm  
23 mm

Länge  
Length

400 mm  
500 mm  
900 mm  
1.000 mm

Bestell-Nr.  
Order No.

HP000.040  
HP000.050  
HP000.090  
HP000.100

## Z-Profil

### Z-profile

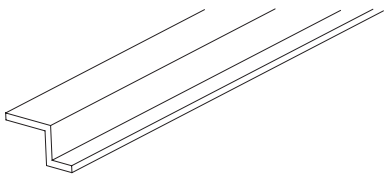

Breite  
Width

16,5 mm  
16,5 mm  
16,5 mm  
16,5 mm

Länge  
Length

400 mm  
500 mm  
900 mm  
1.000 mm

Bestell-Nr.  
Order No.

ZP000.040  
ZP000.050  
ZP000.090  
ZP000.100

## U-Schiene 40/40

### U-profile 40/40

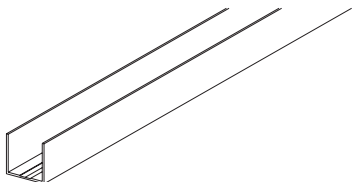

Breite  
Width

40 mm  
40 mm  
40 mm  
40 mm

Länge  
Length

400 mm  
500 mm  
900 mm  
1.000 mm

Bestell-Nr.  
Order No.

UP040.040  
UP040.050  
UP040.090  
UP040.100

Profile  
Profiles

SpeedWall

Alle Profile stufenlos bis 6.000 mm auf Anfrage lieferbar.  
All profiles available up to 6.000 mm infinitely variable on request.

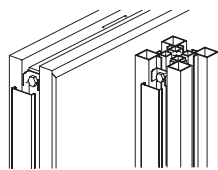

### Abdeckprofil Cover cap profile

Breite Width	Länge Length	Bestell-Nr. Order No.
40 mm	500 mm	AP020.050
40 mm	1.000 mm	AP020.100
40 mm	2.000 mm	AP020.200
40 mm	2.500 mm	AP020.250
40 mm	3.000 mm	AP020.300

Halterung Abdeckprofil  
Clamp cover cap AP000.100

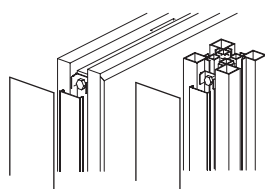

### Abschlußblende 100 „Alu EV1“ Cover cap blind

Breite Width	Länge Length	Bestell-Nr. Order No.
100 mm	2.500 mm	AB250.010
100 mm	3.000 mm	AB300.010

Halterung Abdeckprofil  
Clamp cover cap AP000.100

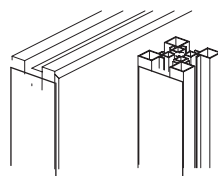

### Abschlußblende 100 „Hartschaum“ Cover cap blind

Breite Width	Länge Length	Bestell-Nr. Order No.
100 mm	2.500 mm	AH250.010
100 mm	3.000 mm	AH300.010



M 8 Gewindekanal  
Gewicht: 4.483 g/m. Anschluß alle 90°  
M 8 thread Weight: 4.483 g/m.  
Connection  
each 90°

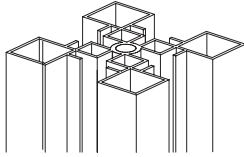

### Quadratstütze 100/100 Square profile 100/100

Länge Length	Bestell-Nr. Order No.
500 mm	ST100.050
1.000 mm	ST100.100
2.000 mm	ST100.200
2.500 mm	ST100.250
3.000 mm	ST100.300

### Quadratstütze 100/100 Stoff Square profile 100/100 fabric

Länge Length	Bestell-Nr. Order No.
1.000 mm	ST100.101
2.000 mm	ST100.201
2.500 mm	ST100.251
3.000 mm	ST100.301

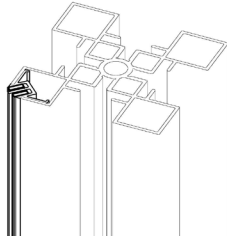

Kopfplatte für Stoffkeder headclamp for fabric welt	ST100.005
--	-----------

### Verbindungsknoten V2A Connection knot V2A

Breite Width	Länge Length	Bestell-Nr. Order No.
100 mm	100 mm	VK100.100
Schraubhalterung Screwclamp		SH020.100

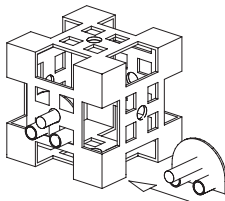

### Rundstütze Ø 100 mm Round column Ø 100 mm

Gewicht:  
5.463 g pro lfdm.  
Anschluß  
alle 11,25°  
Weight:  
5.463 g p. m.  
Connection  
each 11,25°

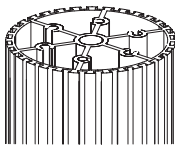

Länge Length	Bestell-Nr. Order No.
1.000 mm	RS100.100
2.000 mm	RS100.200
2.500 mm	RS100.250
3.000 mm	RS100.300

### Einschubprofil für Rundstütze Insertion profile for round column

Gewicht: 691 g pro lfdm.  
Weight: 691 g p. m.

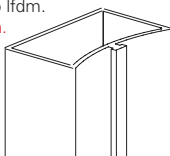

Länge Length	Bestell-Nr. Order No.
1.000 mm	VR020.100
2.000 mm	VR020.200
2.500 mm	VR020.250
3.000 mm	VR020.300

Alle Profile stufenlos bis 6.000 mm auf Anfrage lieferbar.  
All profiles available up to 6.000 mm infinitely variable on request.

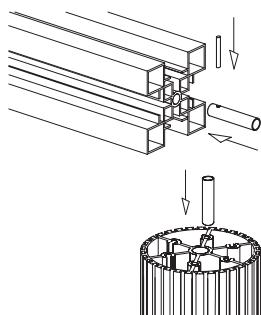

## Gewindeträger Thread carrier

Quadratprofil  
Square profile  
Rundstütze  
Round column

Bestell-Nr.  
Order No.

TQ000.060

TR000.100

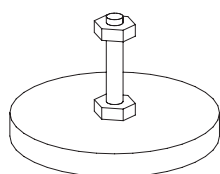

## Verstellfuß Ø 100 mm V2A Adjusting foot Ø 100 mm V2A

Bestell-Nr.  
Order No.

VF000.100

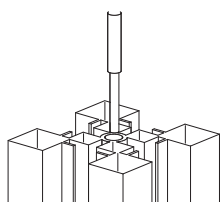

## Verbindung Rundstütze/Quadratprofil Connection round column/square profile

Bestell-Nr.  
Order No.

SV000.100

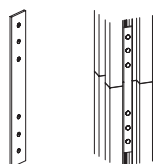

## Träger-, Stützenverbinder 180° Truss, column joint 180°

Länge  
Length

300 mm

Bestell-Nr.  
Order No.

TV000.001

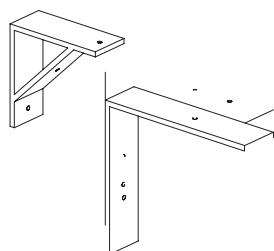

## Winkel Angle truss

klein (60/60)  
small (60/60)  
groß (200/200)  
big (200/200)

Bestell-Nr.  
Order No.

WT050.060

WT050.100

Alle Profile stufenlos bis 6.000 mm auf Anfrage lieferbar.  
All profiles available up to 6.000 mm infinitely variable on request.

# Zubehör Accessories

# SpeedWall

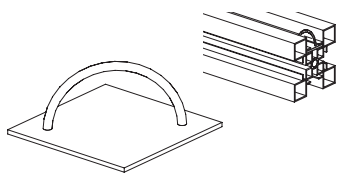

### Abhänger für Träger V2A Hanger for truss V2A

Bestell-Nr.  
Order No.

KH050.050

Taschenfräsung 40/20  
Cut out 40/20

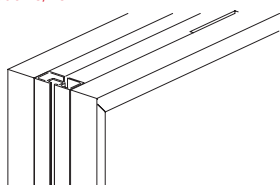

### Einschiebepprofil für Wandrahmen Insertion profile for wallframe

Länge  
Length

Bestell-Nr.  
Order No.

500 mm

AN020.050

1.000 mm

AN020.100

2.000 mm

AN020.200

2.500 mm

AN020.250

3.000 mm

AN020.300

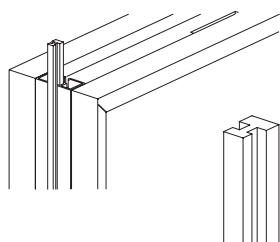

### Verbindungsprofil Kunststoff Connection-profile plastic

Länge  
Length

Bestell-Nr.  
Order No.

500 mm

VK000.050

1.000 mm

VK000.100

2.000 mm

VK000.200

2.500 mm

VK000.250

3.000 mm

VK000.300

### Zargenprofil 20/100 mm Frame-part-profile 20/100 mm

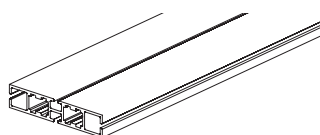

Länge  
Length

Bestell-Nr.  
Order No.

500 mm

ZP100.050

1.000 mm

ZP100.100

2.000 mm

ZP100.200

2.500 mm

ZP100.250

3.000 mm

ZP100.300

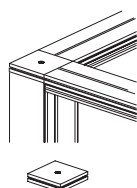

### Rechteckanschluss für Zargenprofil Rectangle connection to frame-part-profile

Bestell-Nr.  
Order No.

ZP100.110

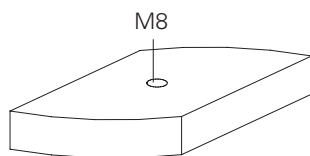

### Nutenstein für Befestigungskanal Slot nut for profile channel

Bestell-Nr.  
Order No.

HM100.010

StahlfüÙe mit Bohrungen für die Befestigung freistehender Wände.  
Steel feet with drill holes for fixation of free standing walls.

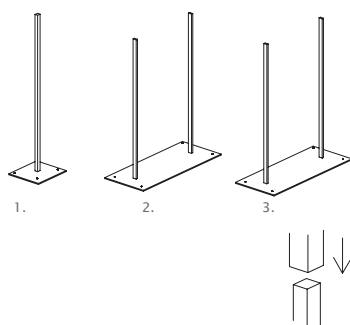

### StahlfüÙe SpeedWall d=10mm Steel feet SpeedWall

Form Form	Länge Length	Bestell-Nr. Order No.
heavy 1	1.450 mm	SF001.150
heavy 2	1.200 mm	SF002.150
light 3	1.200 mm	SF003.150

Bodenplatte nach RAL lackiert  
steel plate painted

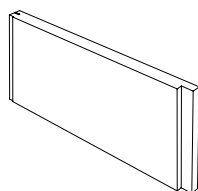

zweiteilig zur Befestigung von LCD Screens o.ä.  
two-piece for mounting LCD screens, etc.

### Verstärkungsplatte Reinforcing Plate

Länge Length	Bestell-Nr. Order No.
900 mm	ZU000.001
1.000 mm	ZU000.002

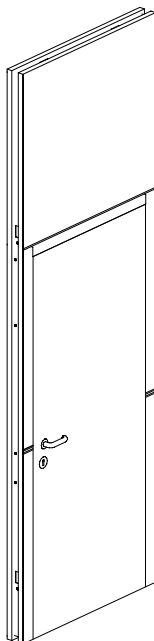

Systemtür: Zarge, inkl. Oberlicht  
System door: door case, incl. toplight

Breite Width	Länge Length	Bestell-Nr. Order No.
1.000 mm	2.500 mm	ZT100.250
1.000 mm	3.000 mm	ZT100.300

Systemtür: Türblatt inkl. Garnitur  
System door: door leaf incl. door handle

	Bestell-Nr. Order No.
Holztür weiß DIN 86 Wooden door white DIN 86	TR000.086
Glastür Glass door	TR000.186
Türanschlag an Quadratstütze Door hinge on square profile	TN000.190

Zubehör  
AccessoriesFeder  
Clip

Breite Width	Länge Length	Bestell-Nr. Order No.
25 mm	40 mm	FE000.001

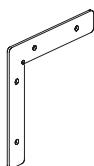
Winkelverbinder für Grundprofil  
Angle joint for basic profile

Breite Width	Länge Length	Bestell-Nr. Order No.
100 mm	100 mm	WI000.010

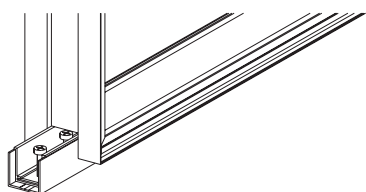
Stellfuß  
Adjusting foot

Breite Width	Länge Length	Bestell-Nr. Order No.
40 mm	330 mm	FP000.030
40 mm	770 mm	FP000.031

SpeedWall

# Grafik-Füllplatten

# Graphic Panels

# SpeedWall

Inkl. Kaschierung auf vorhandene Füllplatte  
Incl. Lamination



## 4c Digitaldruck auf Folie 4c digital foil print

Bestell-Nr.  
Order No.

DR000.001

4c Digitaldruck auf Stretch Stoff  
4c digitalprint on stretch fabric

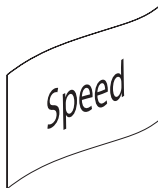

## SpeedWall Stretch Stoff SpeedWall stretch fabric

Bestell-Nr.  
Order No.

bedruckt

printed

DR000.004

unbedruckt

blank

DR000.002

Blockout (einweg)

Blockout (nonreturnable)

DR000.006

Blockout mit Flauschband

Blockout with Velcro tape

DR000.005

bedruckt auf Blockout

printed on Blockout

DR000.007

Folienkaschierung auf vorhandene Füllplatte  
Lamination on existing graphic panel

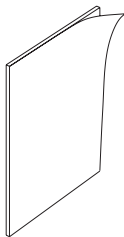

## Folienkaschierung Foil lamination

Bestell-Nr.  
Order No.

DR000.003

Zur Befestigung von Drucken  
For fixing digitalprinting

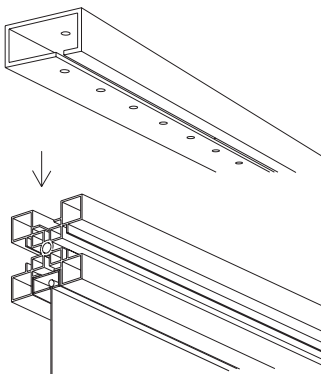

## Multifunktionsprofil 40/20 Multifunctional extrusion 40/20

Länge  
Length

Bestell-Nr.  
Order No.

500 mm

AN021.050

1.000 mm

AN021.100

2.000 mm

AN021.200

2.500 mm

AN021.250

3.000 mm

AN021.300

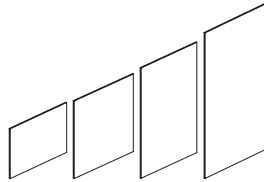

5 mm, weiß  
5 mm, white

## Füllplatten Hartschaumplatte B1 400 Panels expanded plastic slab B1 400

Für Rahmen For frame	Maße Measure	Bestell-Nr. Order No.
400 x 500	395 x 495 mm	PL040.050
400 x 1.000	395 x 995 mm	PL040.100
400 x 2.000	395 x 1.995 mm	PL040.200
400 x 2.500	395 x 2.495 mm	PL040.250
400 x 3.000	395 x 2.995 mm	PL040.300

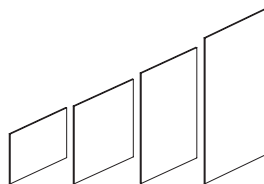

5 mm, weiß  
5 mm, white

## Füllplatten Hartschaumplatte B1 500 Panels expanded plastic slab B1 500

Für Rahmen For frame	Maße Measure	Bestell-Nr. Order No.
500 x 500	495 x 495 mm	PL050.050
500 x 1.000	495 x 995 mm	PL050.100
500 x 2.000	495 x 1.995 mm	PL050.200
500 x 2.500	495 x 2.495 mm	PL050.250
500 x 3.000	495 x 2.995 mm	PL050.300

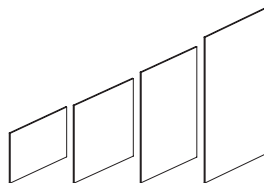

5 mm, weiß  
5 mm, white

## Füllplatten Hartschaumplatte B1 900 Panels expanded plastic slab B1 900

Für Rahmen For frame	Maße Measure	Bestell-Nr. Order No.
900 x 500	895 x 495 mm	PL090.050
900 x 1.000	895 x 995 mm	PL090.100
900 x 2.000	895 x 1.995 mm	PL090.200
900 x 2.500	895 x 2.495 mm	PL090.250
900 x 3.000	895 x 2.995 mm	PL090.300

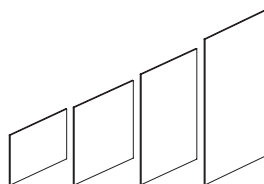

5 mm, weiß  
5 mm, white

## Füllplatten Hartschaumplatte B1 1.000 Panels expanded plastic slab B1 1.000

Für Rahmen For frame	Maße Measure	Bestell-Nr. Order No.
1.000 x 500	995 x 495 mm	PL100.050
1.000 x 1.000	995 x 995 mm	PL100.100
1.000 x 2.000	995 x 1.995 mm	PL100.200
1.000 x 2.500	995 x 2.495 mm	PL100.250
1.000 x 3.000	995 x 2.995 mm	PL100.300

Füllplatten  
Plates

SpeedWall



# Füllplatten rund Plates curved

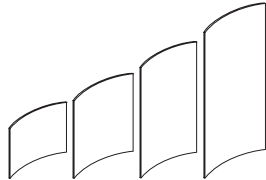

Hartschaumplatte B1 (d=2mm)  
expanded plastic slab B1 (d=2mm)

## Füllplatten für SpeedWall rund Radius 500 Panels for SpeedWall curved radius 500

Maße Measure	Bestell-Nr. Order No.
780 x 495 mm	PLC050.050
780 x 995 mm	PLC050.100
780 x 1.995 mm	PLC050.200
780 x 2.495 mm	PLC050.250
780 x 2.995 mm	PLC050.300

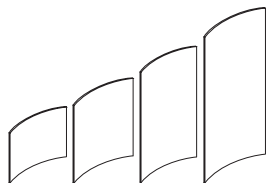

Hartschaumplatte B1 (d=3mm)  
expanded plastic slab B1 (d=3mm)

## Füllplatten für SpeedWall rund Radius 1.000 Panels for SpeedWall curved radius 1.000

Maße Measure	Bestell-Nr. Order No.
1.565 x 495 mm	PLC100.050
1.565 x 995 mm	PLC100.100
1.565 x 1.995 mm	PLC100.200
1.565 x 2.495 mm	PLC100.250
1.565 x 2.995 mm	PLC100.300

# SpeedWall

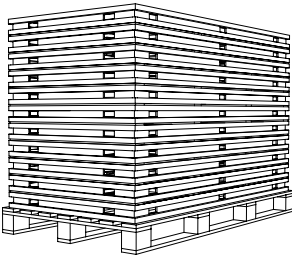

Für 17 Rahmen  
For 17 frames

### SpeedWall Palette SpeedWall palett

Länge  
Length

2.000 mm  
2.500 mm  
3.000 mm

Bestell-Nr.  
Order No.

ZU000.006  
ZU000.007  
ZU000.008



6 Stück pro Rahmen  
6 pcs per frame

### SpeedWall Stapelecken SpeedWall pile corner

Bestell-Nr.  
Order No.

ZU000.014

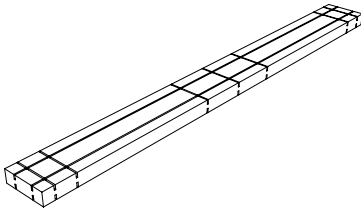

3 Stück pro Rahmen  
3 per frame

### Stapelleisten für Rahmen Frame Slat

Bestell-Nr.  
Order No.

Stapelleiste Multiplex genutet  
Chipboard grooved

ZU000.009

Stapelleiste Multiplex ungenutet  
Chipboard ungrooved

ZU000.010

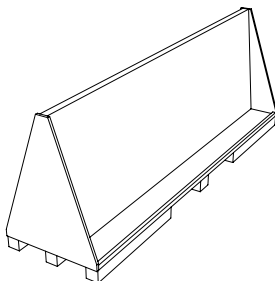

Für bis zu 60 Füllplatten  
For up to 60 panels

### Plattenbock Panel palett

Länge  
Length

2.000 mm  
2.500 mm  
3.000 mm

Bestell-Nr.  
Order No.

ZU000.003  
ZU000.004  
ZU000.005